

# B70-140 Profile



- Universal, linear extruded beam
- Engineered to accept reeded diffusers and parabolic louvre modules
- Applications range from continuous suspended systems, pendant modules, recessed, edge lighting and wall mount task lighting
- SE - Screwless end cap option
- Anodised or powder coat finish

- IP 54 weatherproof option 



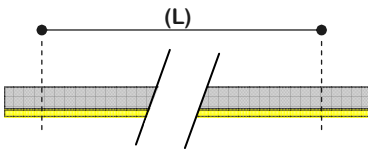

## Specification

Length (m)      **LINEA-LITE**      **B70-140**

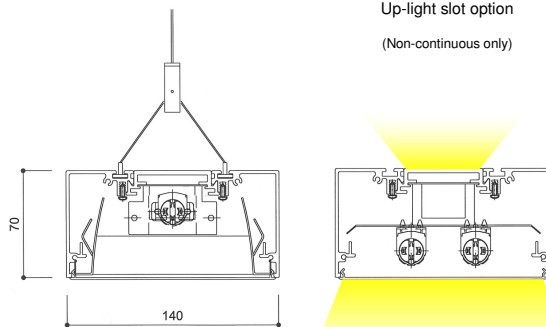

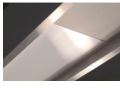
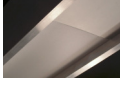
Length allowance	T5-FH	T5-FQ
600mm	14w	24w
900mm	21w	39w
1200mm	28w	54w
1500mm	35w	49w
Length allowance	T8	
610mm	18w	
1220mm	36w	
1530mm	58w	

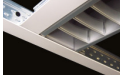

	Clear reed ✓
	Opal reed ✓
	Satin reed ✓
	Satin louvre ✓
	Mirror louvre ✓
	Suspension Kit ✓
	Plaster frame ✓
	T-bar flange ✓

## Photometrics

## Lamps



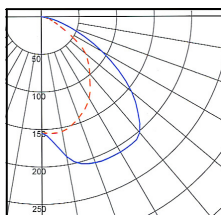

cd / 1000 lamp lumens



Dotted line 0 Degrees  
Solid line 90 Degrees

2/28 T5 Lamp, Satin louvre

Maximum lamps / section

T5		2
T8		2
PL-L		1
MR11, MR16		1

Continuous diffuser

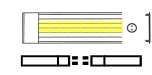

Continuous louvre

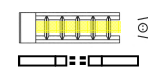

Overlapped lamps ( Diffuser )

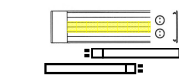

✓	✗	✓ (1-lamp Max)
✓	✗	✗
✓	✗	✗